

# PAC-3<sup>®</sup> MSE Overview

Approved for Public Release – DAL2023100141



# Outline

- PAC-3 Evolution
- Hit-to-Kill Technology
- Patriot and PAC-3 Missile Segment Enhancement (MSE)
- M903 Launcher Upgrades
- Summary and Reference Data



# PAC-3 Evolution

---

PAC-3 missiles defend against incoming threats – including tactical ballistic missiles, cruise missiles and aircraft - through direct body-to-body contact delivering exponentially more kinetic energy on the target than can be achieved with blast-fragmentation kill mechanisms.

Building on the combat-proven PAC-3 Cost Reduction Initiative (CRI), the PAC-3 MSE expands the lethal battlespace with a two-pulse solid rocket motor, providing increased performance in altitude and range.



\*Not to scale

# PAC-3 MSE Historical Timeline

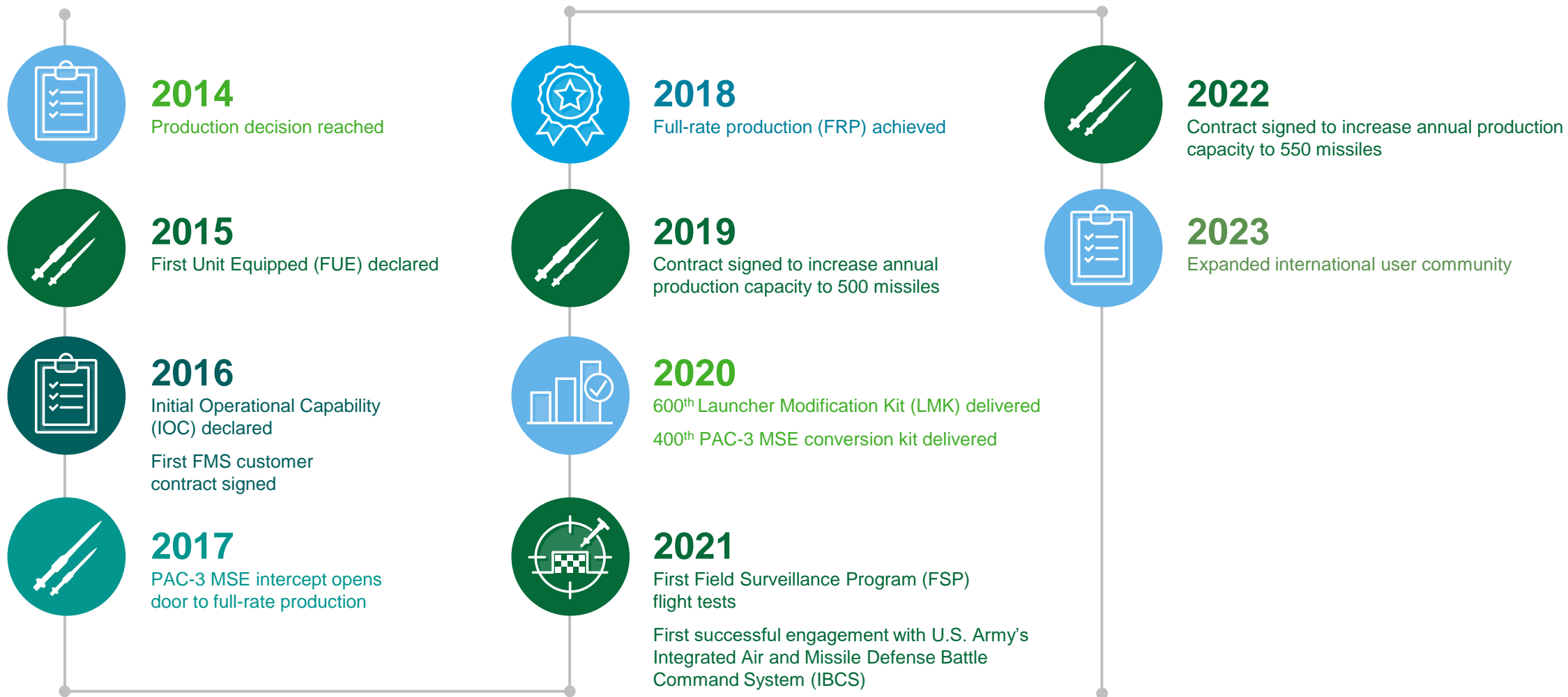

# PAC-3 International User Community

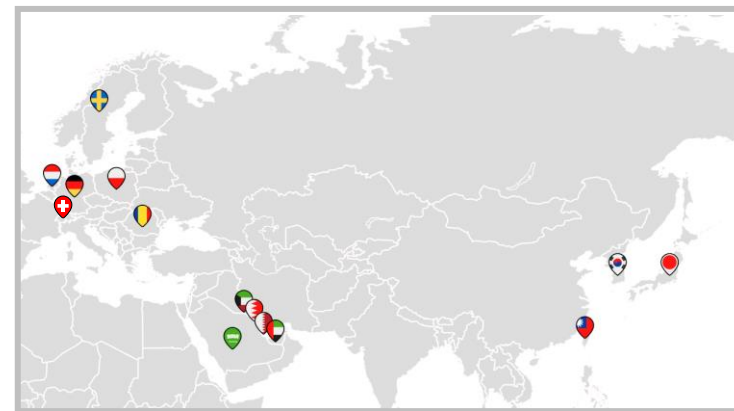
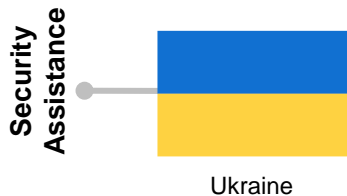
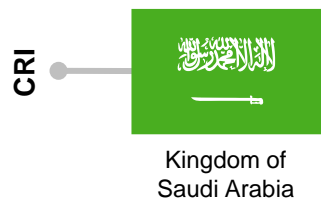
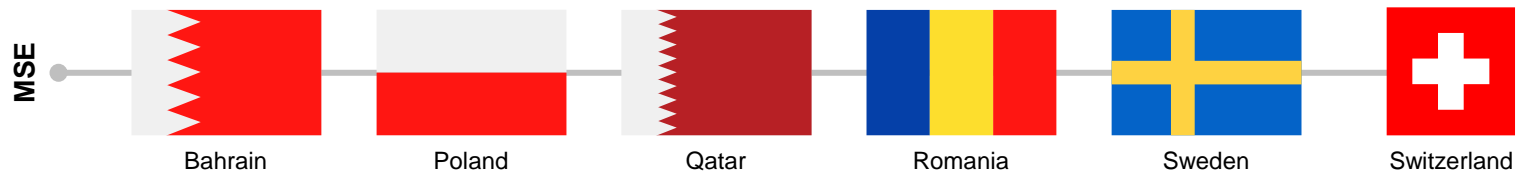
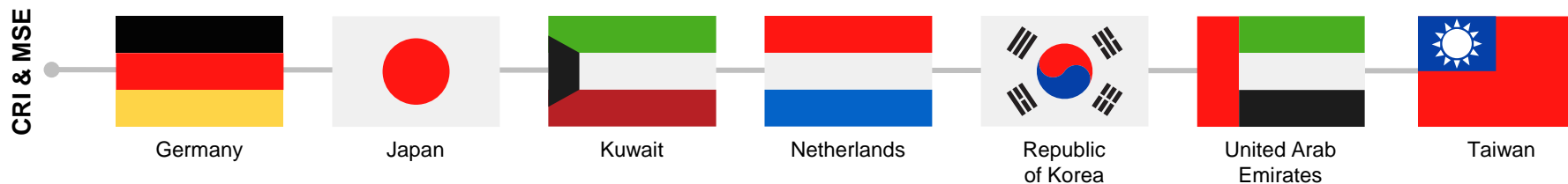

## 14 INTERNATIONAL PAC-3 USERS ON CONTRACT

# PAC-3 International User Community

Europe



Middle East

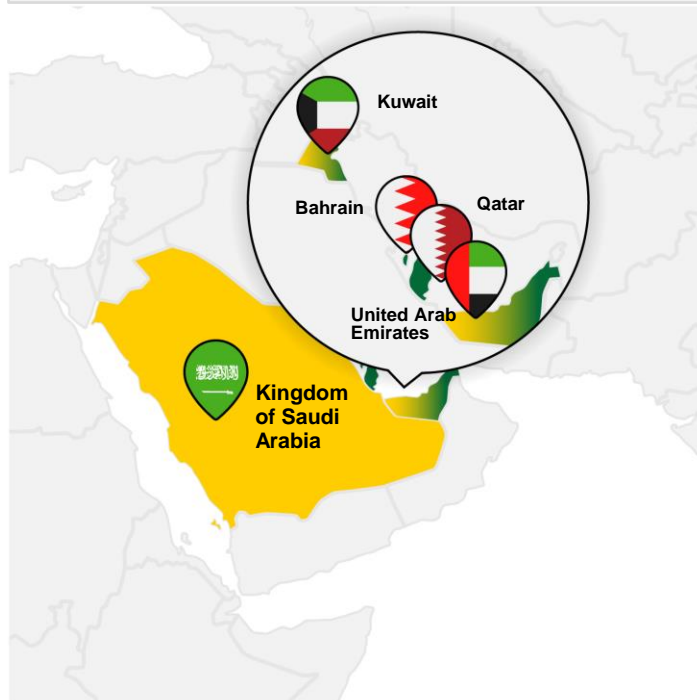

Asia Pacific

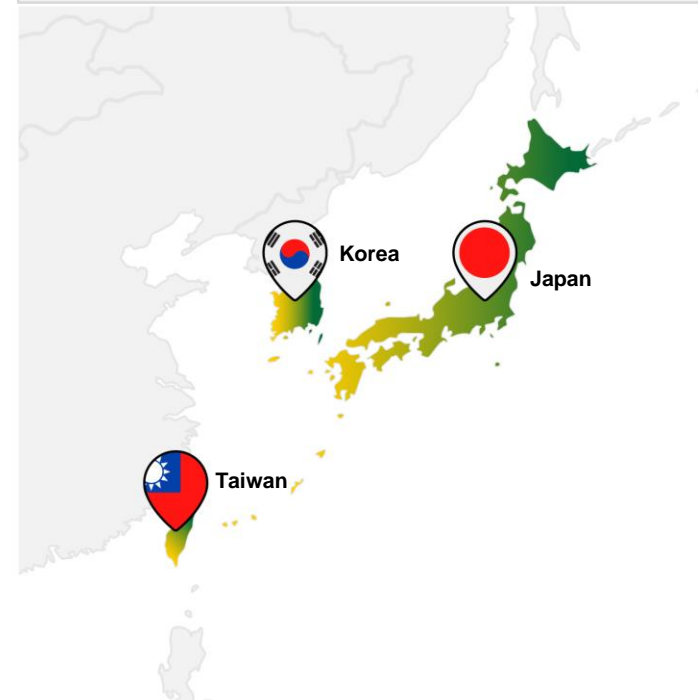

- PAC-3 CRI Customer
- PAC-3 MSE Customer
- Security Assistance to Ukraine

# Hit-to-Kill Technology

---



# PAC-3 Hit-to-Kill Fundamentals



## Sensing the Threat

- Highly accurate seeker
- High data processing rates
- Scanning and search capability



## Guidance

- Optimum engagement geometry
  - Aimpoint selection
- High-speed computing of guidance algorithms
- World-class simulation and testing



## Hitting the Threat

- Extremely responsive control system with forward-mounted side thrusters
- High agility airframe



## Lethality

- High-energy impact defends against current and emerging threats
  - Momentum transfer

# Energy Required for Intercept

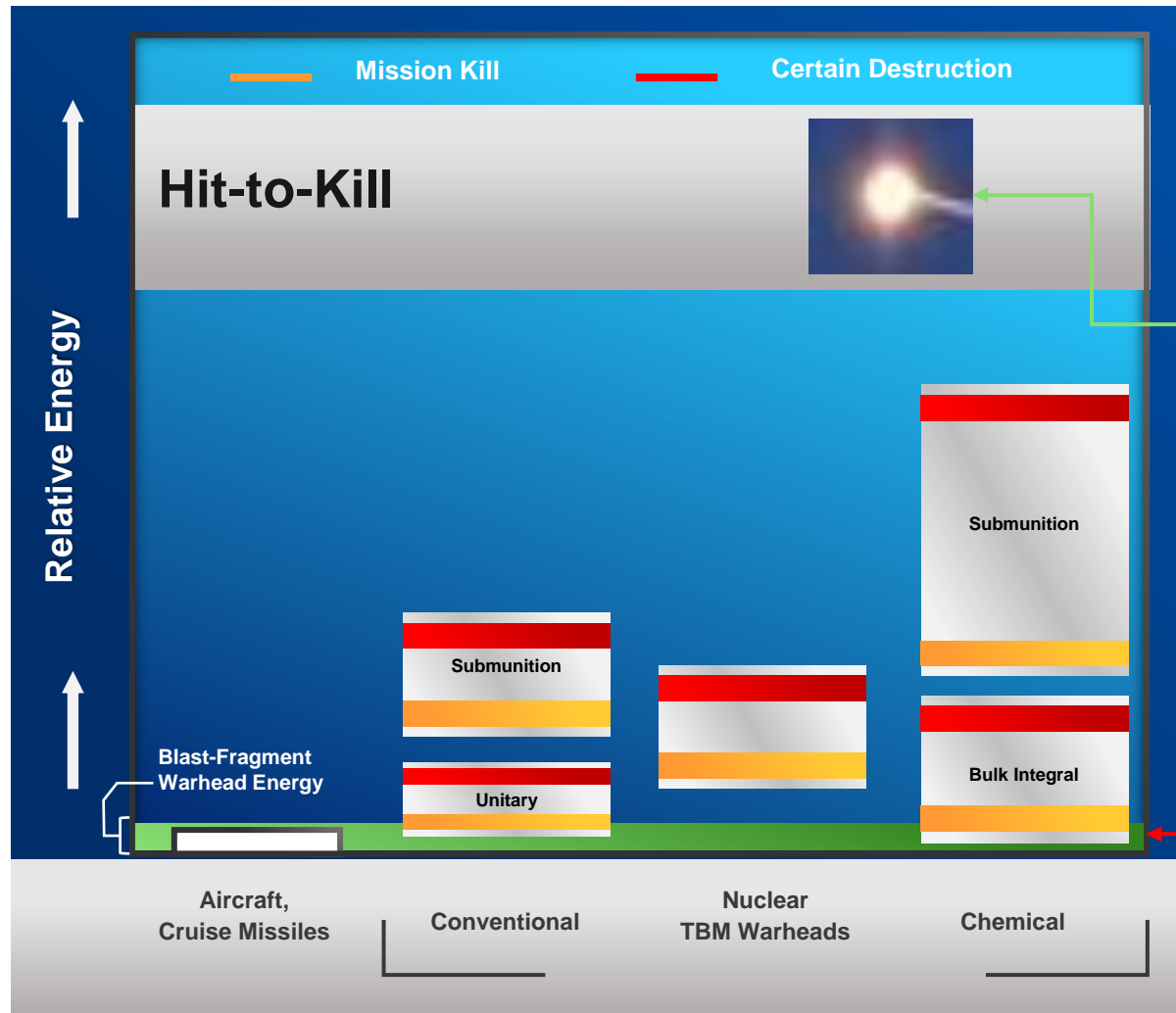

## Effectiveness vs. Submunitions

### Hit-to-Kill Intercept

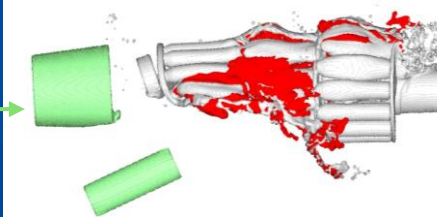

- Typically the aeroshell is destroyed
- Most submunitions are destroyed
- Remaining submunitions typically sustain moderate to significant deformation
- Debris propagates downwards

### Blast Frag Intercept

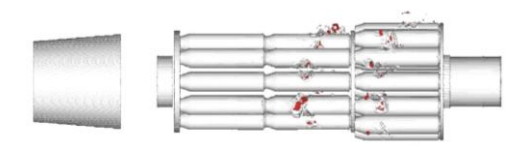

- Typically the aeroshell is destroyed
- Few submunitions are punctured
- Outer layer of submunitions provides effective shielding of inner layer and far-side submunitions
- Ballistic trajectory of debris is generally unchanged

Preventing lethal effects on the ground requires Hit-to-Kill

# Hydrocode Analysis of the Intercept

## Blast Frag Intercept

Delivers a few mega joules of energy on the target

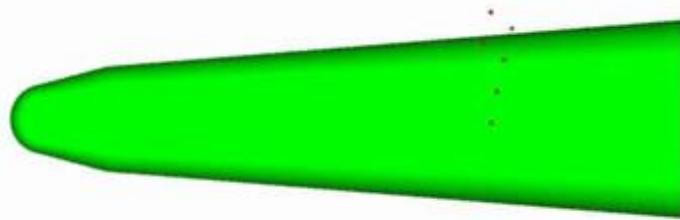

*VIDEO - Click on picture*

## Hit-to-Kill Intercept

Delivers hundreds of mega joules of energy on the target

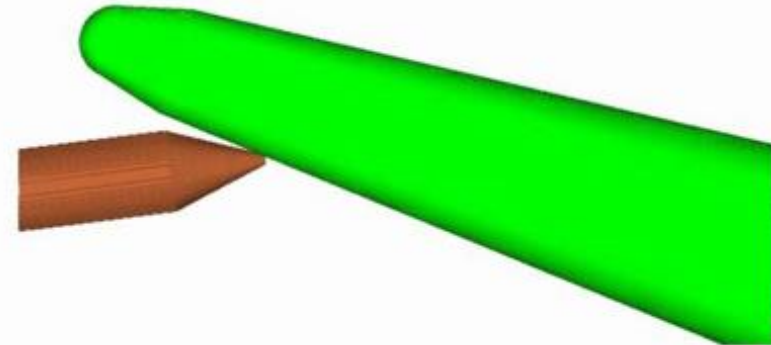

*VIDEO - Click on picture*

Hydrocode provides a means to analyze the intercept dynamics of missile defense intercept mechanisms

# Debris on the Ground

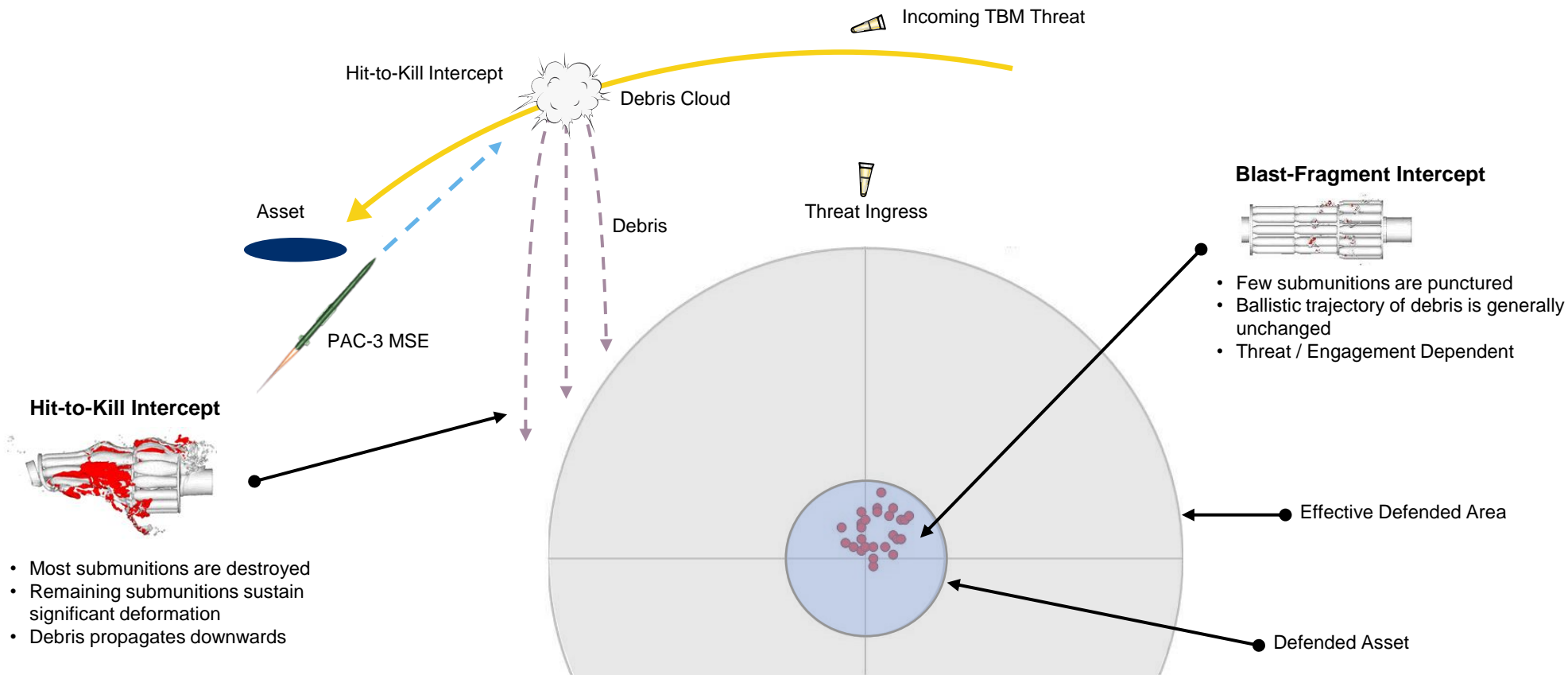

Protect Defended Asset and Minimize Collateral Damage

# PAC-3 Missile Segment

---

# How PAC-3 MSE Works

*\*Patriot Configuration*

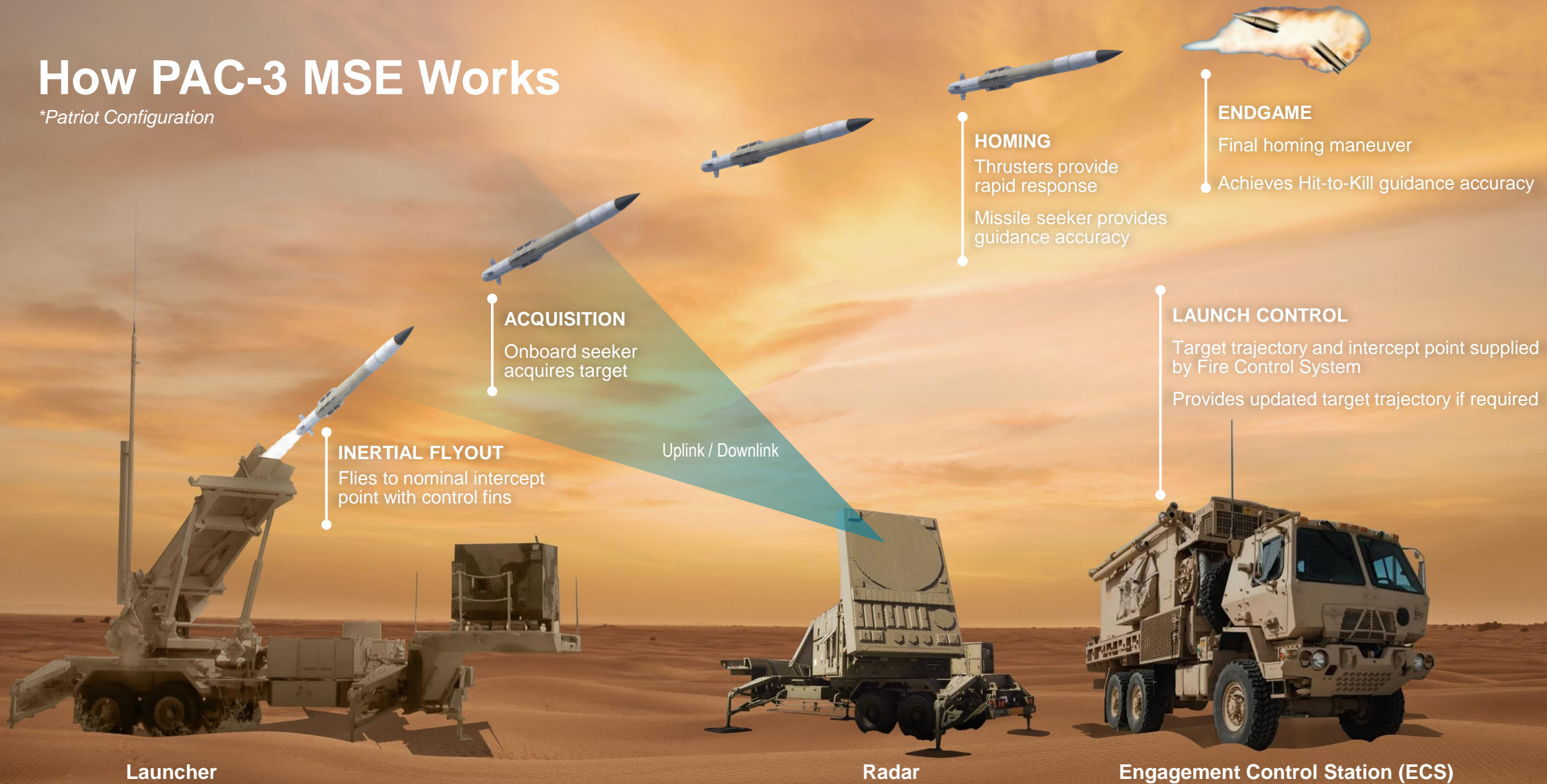

# PAC-3 Missile Segment Components



## M903 Launcher Components

1. PAC-3 MSE One-Packs
2. Junction-Box / Launching Station Diagnostic Unit (J-Box/LSDU)
  - Power/signal distribution for missile umbilicals
  - Performs cable diagnostic test
3. Launcher Cables
  - ELES/J-Box/LSDU interconnect
  - Dedicated umbilicals for PAC-3
4. Enhanced Launcher Electronics System (ELES)
  - Provides power and signals to missiles



## Canister

PAC-3 MSE One-Pack facilitates launcher reconstitution

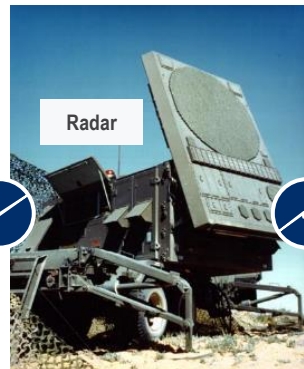

## Fire Solution Computer Redesign (FSCR)

Calculates PAC-3 missile engagement solutions

## PAC-3 Hit-to-Kill Missiles



# PAC-3 MSE Interceptor

- Small (diameter, length, weight)
- Rapid acceleration from solid rocket motor (SRM) boost phase
- Sustain phase maintains high velocity for Hit-to-Kill engagement with second pulse for long-range or high-altitude intercepts
- Dual-control autopilot provides fast divert response
  - Aerodynamic Maneuvering System (control fins)
  - Attitude Control Section - Attitude Control Motors (ACM)
- High-power, highly accurate, all-weather active Ka band radar seeker
  - Range, range rate, angle data to homing guidance
- Guidance Processor Unit (GPU) - Main computer
- Inertial Measurement Unit (IMU) - Navigation system
- Multi-band Radio Frequency Data Link (MRFDL) – Uplink/downlink communication

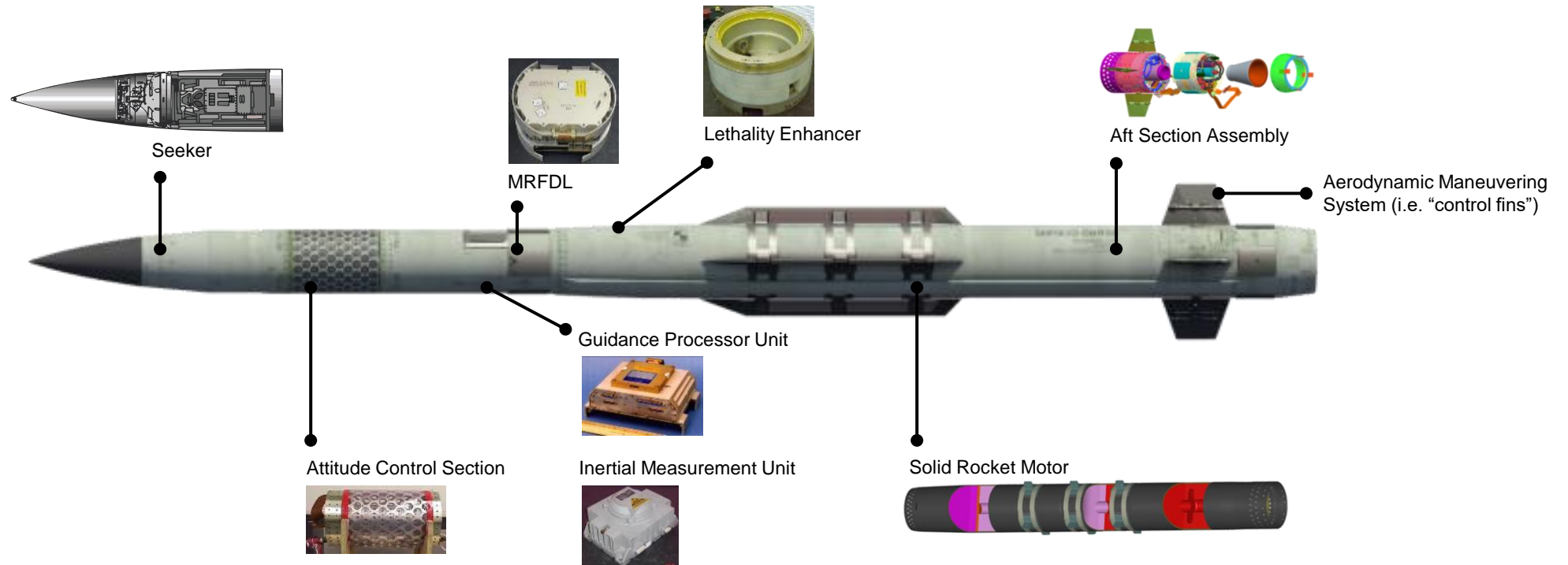



# PAC-3 MSE Capability Enhancements

- Provides performance growth against existing and advanced threats
- Improves lethality and maneuverability over entire battlespace
- Increases footprint significantly against threats
- Provides improved Insensitive Munitions (IM) capability
- One-Pack approach improves operational flexibility
- Achieves larger battlespace with longer range and higher altitude

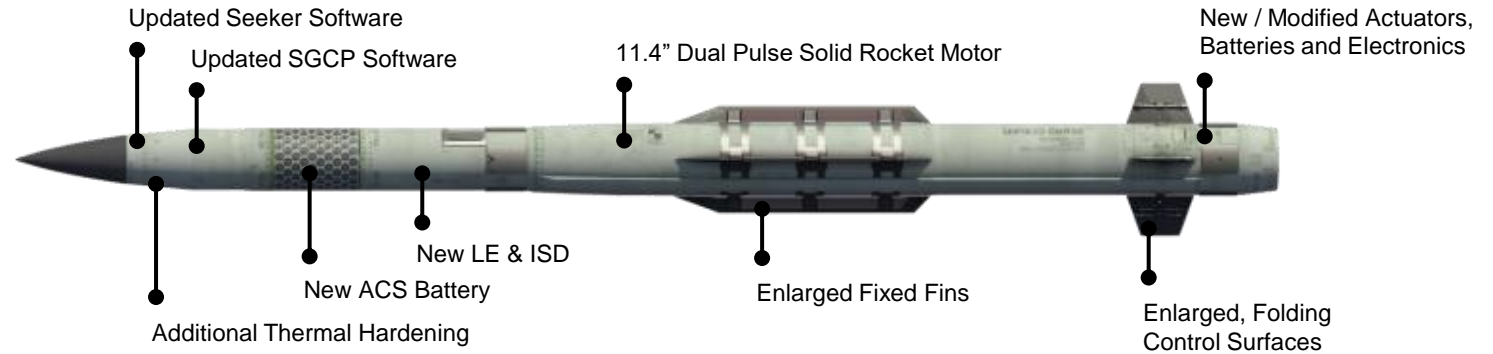

## Significant battlespace growth

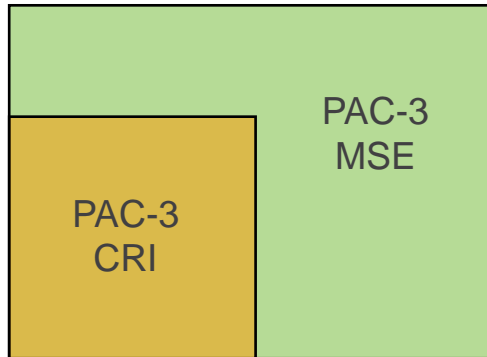

Jointly defined ECS changes with Raytheon

Updated FSCR software



- "Kitted" Single Canister
- Armor
- TIVS
- Updated ELES software

PAC-3 MSE defends against new and evolving threats while increasing capability against existing threats

# PAC-3 MSE Canister Design Overview

## One-Pack, External Components

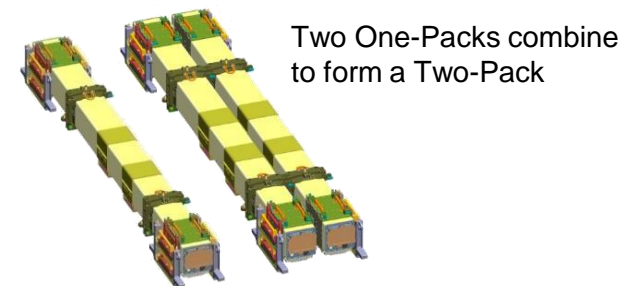
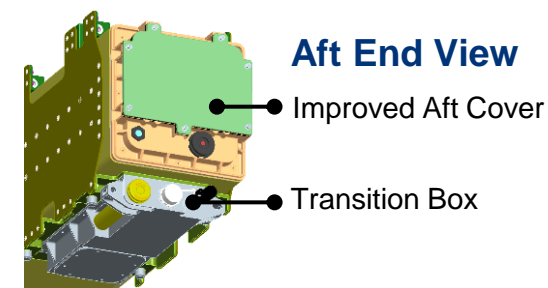
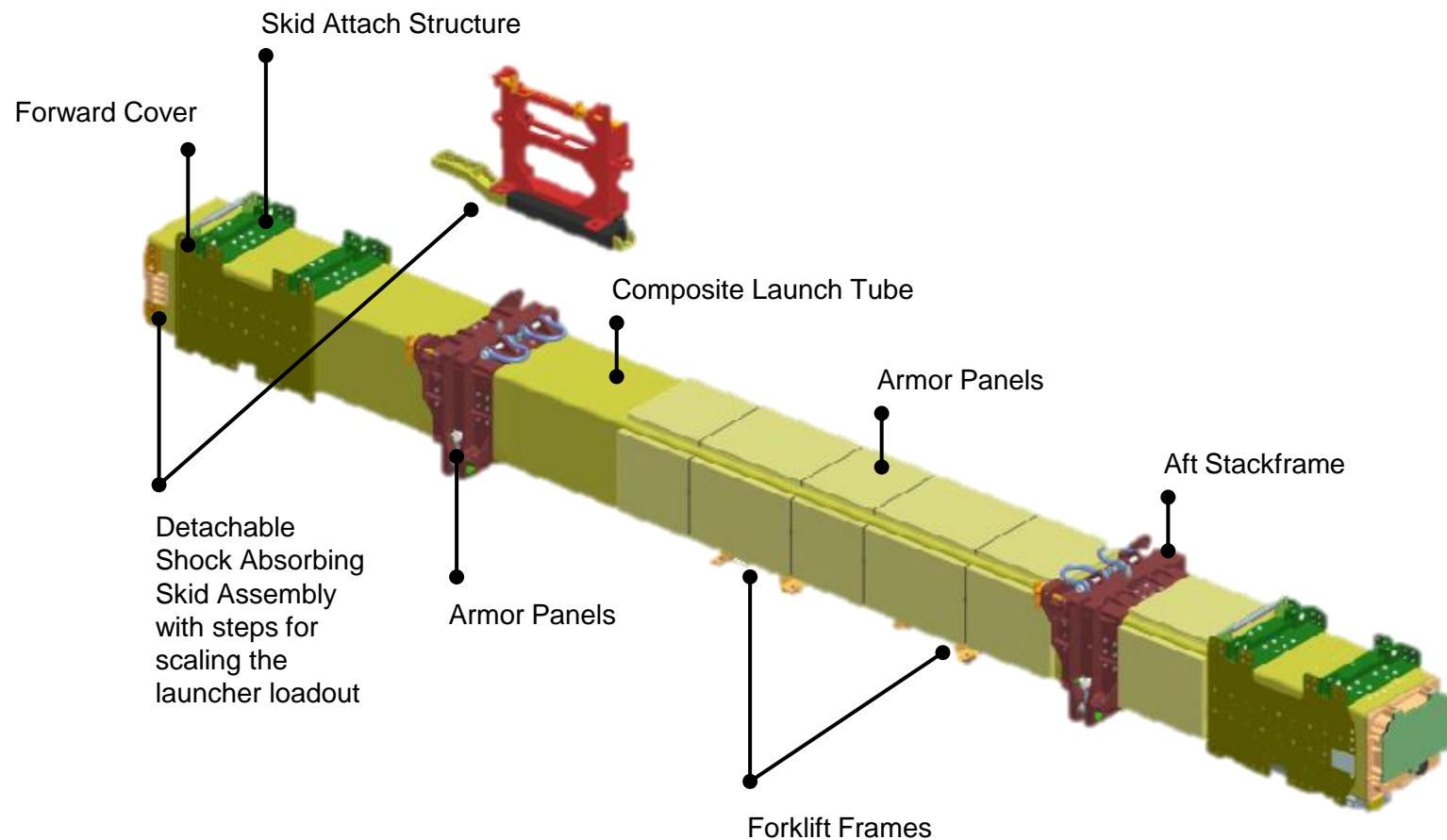

# MSE Single Canister Summary

## Reconstitution / Reload

One-Packs are field replaceable. Single use canister, missiles are not reconstitutable.

## Explosive Ordnance Disposal (EOD) of Single Missile

Single One-Pack may be removed and disposed.

## Shipping Configurations

Can ship as double Two-Pack, Two-Pack, or One-Pack.

## OCONUS Road March

12 missile max load meets OCONUS height requirements without need for off-loading.

## Insensitive Munitions Compliance

System is IM compliant.

## Modularity

Mechanical interfaces maintained for multiple launcher platforms.

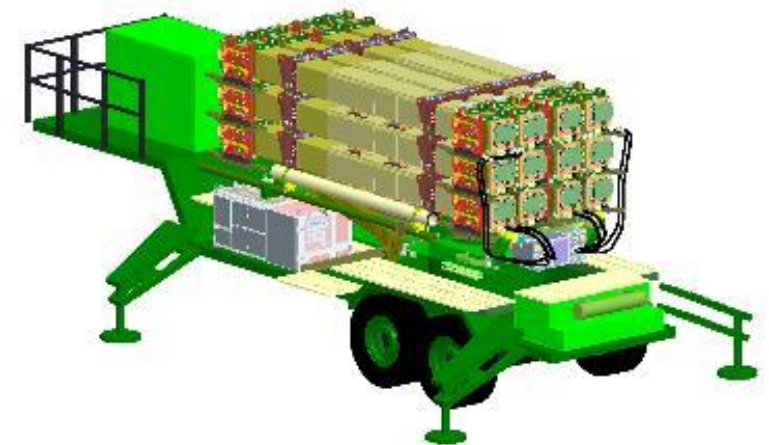
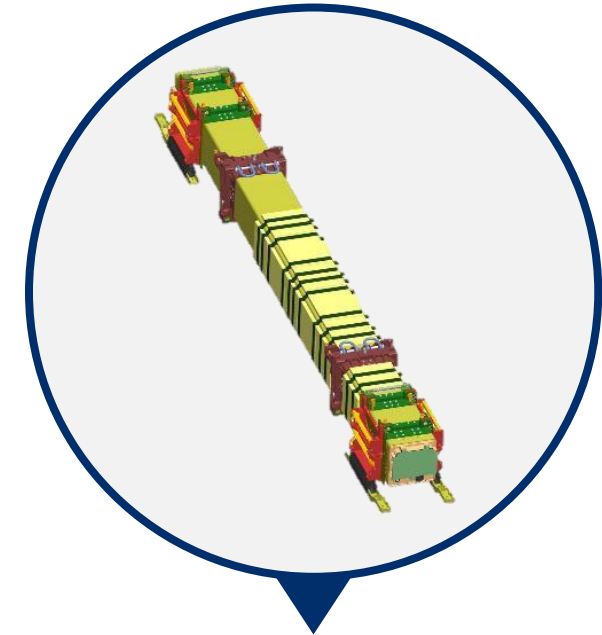

# Launcher Upgrades

---

# PATRIOT Load Out Options

- PAC-3 provides up to four times the firepower and less reloads versus PAC-2 family of missiles.
- PAC-3 CRI and PAC-3 MSE provide high load out configurations and enable defense against mass raids.

- M903 allows for a mix of PAC-3 CRI and PAC-3 MSE missiles.
- All new US launchers are M903 configuration.

## M903 can launch entire family of Patriot missiles



M901

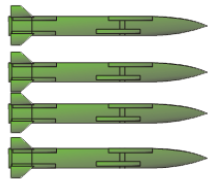

4 PAC-2 (GEM)



M902

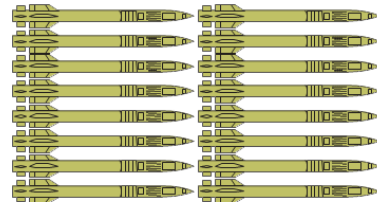

16 PAC-3 CRI  
or 4 PAC-2 (GEM)



M903



12 PAC-3 MSE, or 16 PAC-3 CRI  
or 4 PAC-2 (GEM)

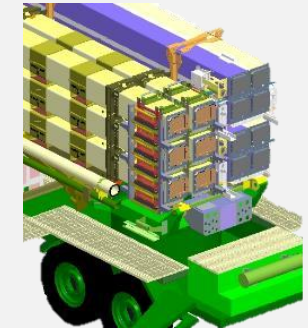

M903

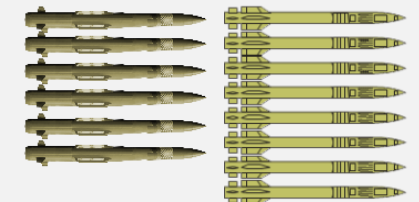

6 PAC-3 MSE and 8 CRI  
or 4 PAC-2 (GEM)

# Summary

---

# Summary

- The PAC-3 family of missiles are **combat proven Hit-to-Kill interceptors** that defend against incoming threats, including tactical ballistic missiles, cruise missiles, advanced threats, and aircraft.
- PAC-3 missiles defend against incoming threats through direct body-to-body contact **delivering exponentially more kinetic energy on the target** than can be achieved with blast-fragmentation kill mechanisms.
- Building on the combat-proven PAC-3 CRI, the PAC-3 MSE **expands the lethal battlespace** with a two-pulse solid rocket motor, providing increased performance in altitude and range.
- **Fifteen** nations have chosen PAC-3 to provide missile defense capabilities.



World's Most Advanced  
Air Defense Missile

***LOCKHEED MARTIN*** 



# Acronyms

<b>ABT</b>	Air Breathing Threat	<b>GSE</b>	Ground Support Equipment	<b>PALS</b>	PATRIOT Automated Logistics System
<b>ACM</b>	Attitude Control Motors	<b>GTF</b>	Guided Test Flight	<b>POP</b>	Proof of Principle
<b>ACS</b>	Attitude Control System	<b>HTK</b>	Hit-to-Kill	<b>REP</b>	Radar Enhancement Phase
<b>AMS</b>	Aerodynamic Maneuvering System	<b>HW</b>	Hardware	<b>RDP</b>	Radar Digital Processor
<b>ARM</b>	Anti-Radiation Missile	<b>IM</b>	Insensitive Munitions	<b>RF</b>	Radio Frequency
<b>CDI</b>	Classification, Discrimination, Identification	<b>IMU</b>	Inertial Measurement Unit	<b>RLCEU</b>	Remote Launch Communications Enhancement Upgrade
<b>Config</b>	Configuration	<b>IOC</b>	Initial Operational Capability	<b>RPV</b>	Remotely Palletized Vehicle
<b>CONUS</b>	Continental United States	<b>ISD</b>	Ignition Safety Device	<b>SBC</b>	Single Board Computer
<b>COTS</b>	Commercial off-the-shelf	<b>J-Box</b>	Junction Box	<b>SGCP</b>	System Guidance Computer Program
<b>CRI</b>	Cost Reduction Initiative	<b>Km</b>	Kilometer	<b>SIG</b>	Signal
<b>D-Cables</b>	Distribution Cables	<b>LE</b>	Lethality Enhancer	<b>SP</b>	Shorting Plug
<b>D-Box</b>	Distribution Box	<b>LEM</b>	Launcher Electronics Module	<b>SRHIT</b>	Small Radar Homing Interceptor Technology
<b>DT</b>	Development Test	<b>LMRD</b>	Launcher Missile Round Distributor	<b>SRM</b>	Solid Rocket Motor
<b>ECS</b>	Engagement Control Station	<b>LS</b>	Launching Station	<b>SW</b>	Software
<b>ELES</b>	Enhanced Launcher Electronics System	<b>LMK</b>	Launcher Modification Kit	<b>TBM</b>	Tactical Ballistic Missile
<b>EOD</b>	Explosive Ordnance Disposal	<b>LSDU</b>	Launcher Station Diagnostic Unit	<b>T-Box</b>	Transition Box
<b>ERINT</b>	Extended Range Interceptor	<b>MAP</b>	Modular Adjunct Processor	<b>THAAD</b>	Terminal High Altitude Area Defense
<b>EWCC</b>	Expanded Weapons Control Computer	<b>MEADS</b>	Medium Extended Air Defense System	<b>TIVS</b>	Thermally Initiated Venting System
<b>FLAGE</b>	Flexible Lightweight Agile Guided Experiment	<b>MFG</b>	Master Frequency Generator	<b>UMB</b>	Umbilical Cable
<b>FMS</b>	Foreign Military Sales	<b>MRFDL</b>	Multi-band Radio Frequency Downlink	<b>UL</b>	Upper Left
<b>FOTP</b>	Follow-on Test Program	<b>MSE</b>	Missile Segment Enhancement	<b>UR</b>	Upper Right
<b>FSC</b>	Fire Solution Computer	<b>MSL</b>	Missile	<b>VME</b>	Versa Module Eurocard
<b>FSCR</b>	Fire Solution Computer Redesign	<b>NFS</b>	North Finding System	<b>WMD</b>	Weapon of Mass Destruction
<b>FUE</b>	First Unit Equipped	<b>OCONUS</b>	Outside the Continental United States		
<b>FWD</b>	Forward	<b>OT</b>	Operational Test		
<b>GEM</b>	Guidance Enhancement Missile	<b>PAC-3 @</b>	Patriot Advanced Capability-3		
<b>GMT</b>	Guided Missile Transporter	<b>PDB</b>	Post Deployment Build		
<b>GPU</b>	Guidance Processor Unit				